

We are Technically Associated with



Ishwari Plaza, Telibandha Main Road,
Moulipara, Telibandha, Raipur,
Chhattisgarh - 492001

Call Us :
+91 81030 33440

E-mail :
hoistelevators.2@gmail.com

Website :
<http://www.hoistelevators.net>

Branch :
2. Near Lafagarh Gas Godown,
Shubham Vihar, Bilaspur, Chhattisgarh.

Quality
That Takes You High



- Traction Elevator
- MRL Elevator
- Hydraulic Elevator





“Success Through Customer Service Is Our Objective”

About Us :

Hoist means to move upwards and grow. hoist Elevators adheres to strict quality measures and safety solutions that take you on a high!

We study international trends continuously and upgrade elevators for customers and that is the reason we provide a comprehensive product range in elevators. Our elevators are engineered to meet the mobility needs for a variety of applications from residential to commercial and from shopping malls to airports. Our solutions for your building range from highly standardized features to a fully customized elevator.

We have started this company with a vision to provide high-quality mobility solutions and services at all times. Customer safety is a top priority for us.

Different Type of Elevator Technology

Machine Room System (MR)

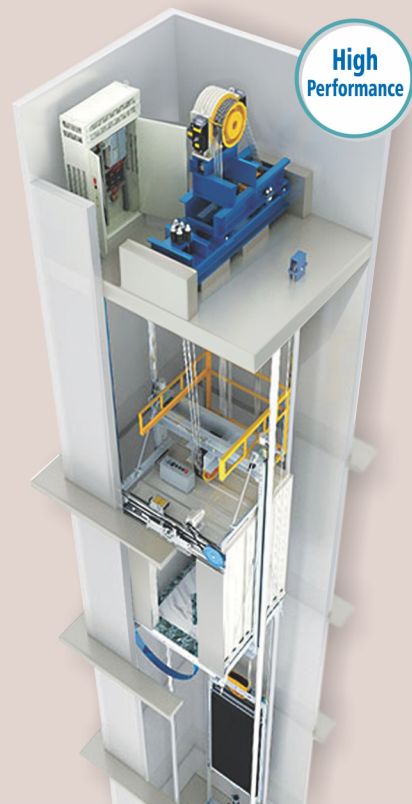

High Performance

HOIST Elevators Provides “best in class” ride quality on every equipment installed.

Machine room passenger elevator is one of most popular product in both private and public sectors.

The Machine room is an area set aside for the elevator equipment such as controllers and mechanical unit.

Machine Roomless System (MRL)



Reduction in Elevator Equipment Area of 40%

The Machine room-less elevator is a great leap in technology. MRL elevator not only look fabulous in new constructions and major renovation projects but when compared to standard elevator equipment, it saves substantial construction space reducing building expenses and is upto 40% energy efficient. Its features include excellent reliability and durability, is oil free and operates silently.

Hydraulic System (MRL)

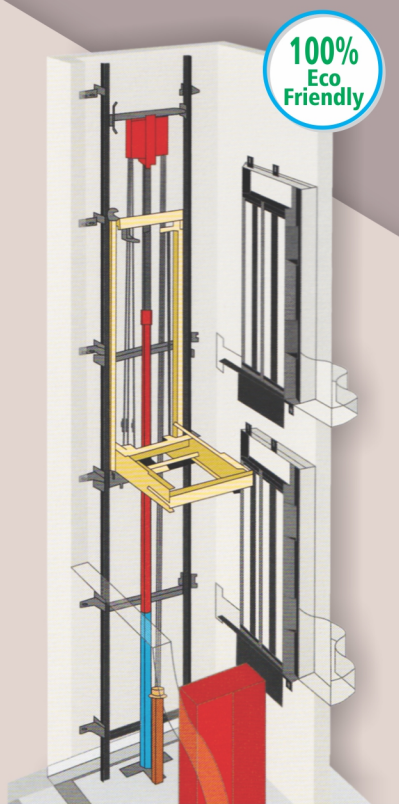

100% Eco Friendly

Lift which are powered by a piston that travels inside a cylinder.

An electric motor pumps hydraulic oil into the cylinder to move the piston.

The piston smoothly lifts the elevator cab. Electrical valves control the release of the oil for a gentle descent.

Capsule Elevator



Smooth Operation
Comfortable Travel



Panoramic Elevator

Our premium capsule elevators fast and highly cost-effective way to create a full-glass elevator solution for your building.

There are multiple car models to choose from, as well as a wide range of interior design options and other customization possibilities.



Features

- Attractive Looks.
- Unique Features
- Transparent
- Beautiful Designs

Available Rated Speed : 1.0 , / 1.5 / 2 MPS
 Max Travel Height : 66 M
 Available Rated Capacity : 408 to 1088 Kgs
 Max Passengers : 06 to 16 Passengers



Square Full Glass Cabin



Round Carved Glass Cabin

There is a variety of forms to meet different needs.

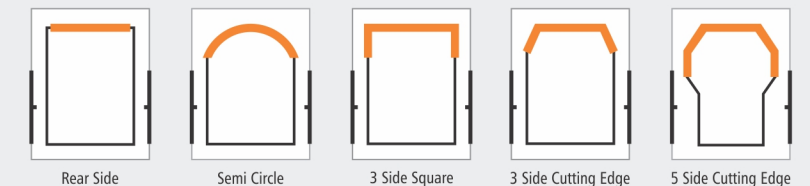

Three Side Designer Cabin



Powder Coated Round Glass Cabin

Construction Layout - Round Glass

Load		Car Inside				Lift Well				Entrance
Person	Kgs.	A	B	J	G	C	D	F	H	E
10	680	1100	1300	1400	650	2200	1325	1330	1100	800
13	884	1200	1400	1550	700	2400	1425	1430	1100	900
16	1088	1300	1500	1700	750	2800	1530	1530	1200	1000

Construction Layout - Three Side Glass

Load		Car Inside			Lift Well				Entrance
Person	Kgs.	A	B	G	C	D	F	H	E
10	680	1250	1300	250	2200	1450	1480	580	800
13	884	1400	1400	300	2400	1550	1630	650	900
16	1088	1550	1500	350	2800	1780	1650	790	1000

Manual Door

Passenger Elevator

Hoist Elevators Manual door elevators are durable by design and accurate by technology. We have a wide range of these elevators which are most reliable and designed to suit every construction requirement and provide best vertical transportation solutions, with trouble free performance and low maintenance cost. These elevators are a perfect blend of Cost friendly and robust performance elevator applications. They have an excellent record of customer satisfaction.

Available Rated Speed : 0.63 / 1.0, / 1.5 / 2 MPS
 Max Travel Height : 66 M
 Available Rated Capacity : 272 to 1360 Kgs
 Max Passengers : 04 to 20 Passengers



When passengers ride your elevators you want them safe

Automatic Door

Passenger Elevator



Elevators that Ride so Smoothly

HOIST ELEVATORS has been engineered with full automatic doors. Fabricated with most advanced lift controls, appreciated for their high speed, smooth travel and perfect leveling different types of doors Center Opening, Telescopic Opening.

Automatic Parking Function

In case of breakdown and parking not at the door, the system will start automatic parking function and open the door when the car runs to the middle floor so as to ensure passenger safety.

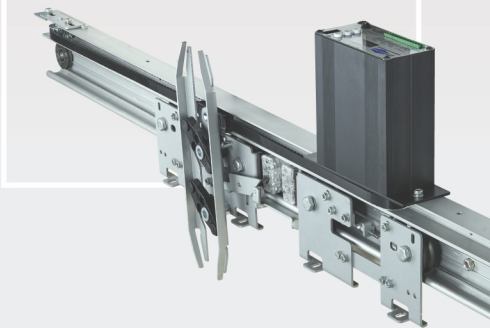

Available Rated Speed : 0.63 / 1.0, / 1.5 / 2 MPS
 Max Travel Height : 66 M
 Available Rated Capacity : 408 to 1360 kgs.
 Max Passengers : 06 to 20 Passengers



HOIST WAY MACHINE ROOM SIZE (Auto Doors) Automatic Centre Opening Doors - Passenger Lifts

No. of Person	Rated Capacity	Speed	Entrance Width (E)	Car Size (A X B)	Hoistway Dimensions (C X D)	Pit	Machine Room
	KG	M/S	MM	MM	MM	MM	MM
6	408	1.00	700	1100 X 1000	1600 X 1600	1600	2400 x 3300
		>1.50<1.75					
		2.5					
8	544	1.00	800	1100 X 1300	1750 X 1700	1800	2500 x 3500
		>1.50<1.75					
		2.5					
10	680	1.00	800	1300 X 1350	1750 X 1950	1800	2500 x 3500
		>1.50<1.75					
		2.5					
13	884	1.00	900	1500 X 1470	2175 x 1900	1600	3000 x 3600
		>1.50<1.75					
		2.5					
16	1088	1.00	1000	1700 X 1530	2450 x 2000	1800	3000 x 3600
		>1.50<1.75					
		2.5					
20	1360	1.00	1000	1900 X 1580	2550 x 2050	1600	3000 x 4000
		>1.50<1.75					
		2.5					

Automatic Telescopic Doors - Passenger Lifts

No. of Person	Rated Capacity	Speed	Entrance Width (E)	Car Size (A X B)	Hoistway Dimensions (C X D)	Pit	Machine Room
	KG	M/S	MM	MM	MM	MM	MM
6	408	1.00	700	970 X 1150	1400 X 1750	1800	2400 x 3300
		>1.50<1.75					
		2.5					
8	544	1.00	800	1100 X 1300	1525 X 1925	1800	2500 x 3500
		>1.50<1.75					
		2.5					
10	680	1.00	800	1190 X 1475	1600 X 2100	1800	2500 x 3500
		>1.50<1.75					
		2.5					
13	884	1.00	900	1200 X 1840	1850 X 2300	1600	3000 x 3600
		>1.50<1.75					
		2.5					
16	1088	1.00	1000	1300 X 2000	1950 X 2400	1600	3000 x 3600
		>1.50<1.75					
		2.5					
20	1360	1.00	1000	1500 X 2000	2100 X 2400	1600	3000 x 4000
		>1.50<1.75					
		2.5					

HOIST WAY MACHINE ROOM SIZE (Manual Doors)

LOAD		CAR INSIDE		LIFT WELL		ENTRANCE	MACHINE ROOM			SPEED	PIT	OVER
PER.	WEIGHT	WIDTH	DEPTH	WIDTH	DEPTH	E	WIDTH	DEPTH	HEIGHT	MPS	DEPTH	HEAD
	IN KG.	A	B	C	D		F	G	H			
4	272	1100	700	1600	1250	700	3000	3000	2500	UP TO 1.5	1600	4800
5	340	1100	850	1600	1300	750	3000	3200	2500			
6	408	1100	1000	1670	1370	750	3000	3500	2500			
8	544	1300	1100	1800	1600	750	3200	3500	2500			
10	680	1350	1300	1850	1800	1000	3500	4000	2500			
13	884	2000	1100	2500	1600	1000	4000	4200	2500	OVER 1.5	2600	6700
16	1088	2000	1300	2500	1800	1000	4500	4800	2500			
20	1360	2000	1550	2500	2050	1000	5000	5000	2500			

• All Dimension are in mm. • This is General Data, it may be changed without notice. • All hoist way walls should be minimum 230 mm brick or 150 mm R. C. C.



Variation of Manual Door



Manual Collapsible Door Manual Imperforated Door M.S. Powder Coated Frame Full Glass Swing Door M.S. Manual Swing Door Manual Telescopic Door Manual Telescopic Door

Variation of Autodoor



Center Opening Auto Door (Small Vision) Hairline Finish Telescopic Auto Door Rose Gold Center Opening Autodoor Center Opening Glass Auto Door (Big Vision) Center Opening Glass Auto Door (Half Vision) Center Opening Glass Auto Door (Full Vision)

Hospital Elevator

Providing Effortless Vertical Solution with Prior Safety



Hospital Elevators provide easy transportation of patients and bulky medical equipment such as gurney, stretchers and wheel chairs. These lifts feature sophisticated looks and operated smoothly.

Hospital Elevators are available in a wide variety, capable of carrying between 08 to 20 passengers at a time. These elevators usually feature center-opening, telescopic power-operated doors and easy to use for people

Available Rated Speed : 0.63 / 1 MPS
 Max Travel Height : 66 M
 Available Rated Capacity : 1020 to 1768 Kgs
 Max Passengers : 15 to 26 Passengers

Looking for Hospital lifts?
 We know we can help

Safety Door Edge (SDE)
 A mechanical safety device with a micro-switch reverses closing doors if there is physical contact with a passenger or an object.

-  Intellectual Control
-  Noise Reducing
-  Smooth and Comfortable

Automatic Centre Opening Door - Hospital Lifts

No. of Person	Rated Capacity	Entrance Width	Car Size	Hoistway Dimensions	Machine Room
	KG	E	A X B	C X D	MA X MB
10	680	800	900 X 1950	1750 X 2500	2500 X 3500
15	1020	900	1000 X 2400	1950 X 3000	3000 X 3600
20	1360	1000	1300 X 2400	2200 X 3000	3000 X 4000
26	1768	1200	1600 X 2400	2600 X 3000	3000 X 4000

Collapsible Door can be provided if required.

Automatic Telescopic Door - Hospital Lifts

No. of Person	Rated Capacity	Entrance Width	Car Size	Hoistway Dimensions	Machine Room
	KG	E	A X B	C X D	MA X MB
10	680	800	900 X 1950	1550 X 2500	2500 X 3500
15	1020	900	1000 X 2400	1750 X 3000	3000 X 3600
20	1360	1000	1300 X 2400	2050 X 3000	3000 X 4000
26	1768	1200	1600 X 2400	2350 X 3000	3000 X 4000

- All dimensions in mm. • This is general data, it may be changed without notice. For more details contact us.
- All hoist way walls should be minimum 230 mm brick or 150 mm RCC.

Goods Elevator

Optimized intellectual properties Bear any heavy load at easy



Freight Elevator

We apply the fully computerized modular elevator special control system, effective and reliable drive mode, sensitive and flexible VVVF variable frequency door machine for HOIST serial freight elevator so that our elevator can have relaxed transport under various work conditions. High strength car structure, anti-collision strip, photocell door setting can satisfy all kinds of the freight transport. They are also applicable for different building structures. As a result, we can tackle more and more transport tasks at ease and create a completely new freight carrying concept as well.

Available Rated Speed : 0.50 / 1.00 / 1.50 MPS
 Max Travel Height : 66 M
 Available Rated Capacity : 500 to 5000 Kgs

Super strong loading capacity multiple consideration



Heavy Duty Traction Machine

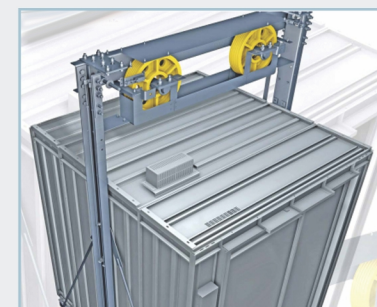

Heavy Structure Cabin



Sturdy and Durable

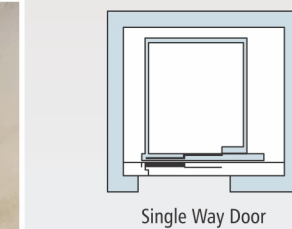

Single Way Door

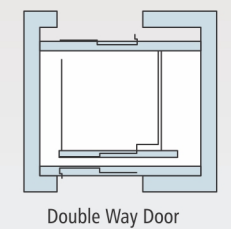

Double Way Door

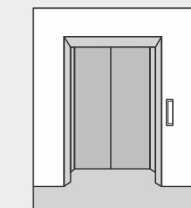

Two Panel Sliding Panel

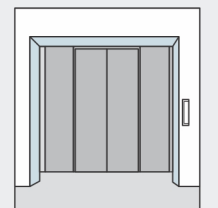

Center Opening & Double Folded



Accurate Leveling



Large Door Width

CAPACITY	SHAFT-W	SHAFT-D	CAR-W	CAR-D	ENTRANCE	LOAD KG	SPEED MPS	PIT DEPTH	OVER HEAD
Kgs.	(C)	(D)	(A)	(B)	(E)				
500	1900	1500	1100	1200	900	500 - 3000	0.25 - 1.0	1600	4800
1500	2600	2300	1700	2000	1400				
2000	2600	2800	1700	2500	1400				
3000	2900	3300	2000	3000	1700	4000 - 5000	0.25	2200	7400
4000	3400	3400	2500	3000	1900				
5000	3500	4300	2500	3600	1900				

- All dimensions are in mm.
- These dimensions are based on vertical bi-parting doors, it may vary for collapsible or automatic door operation.

Car Elevator



Safe and convenient

HOIST Automobile elevator gives a full use of the years' automobile manufacture technology from India HOIST Elevators Company. It applies the highly well-developed variable voltage, variable frequency control technology, precise speed governor control. It avoids noids and car-shake due to enlarged burden of traction system because of uneven encountered force to the car. It optimizes the characteristics of this series to the greatest extent.

Available Rated Speed : 0.30 / 0.50 MPS
 Max Travel Height : 30 M
 Available Rated Capacity : 2500 to 4000 Kgs
 Segment : Industrial applications & Car Parks



Application

- Residential and Commercial Buildings - New and Existing
- Parking Structures - New and Existing
- Public Buildings like Malls, Airports etc
- Automobile Showrooms and Repairs Building - New and Existing

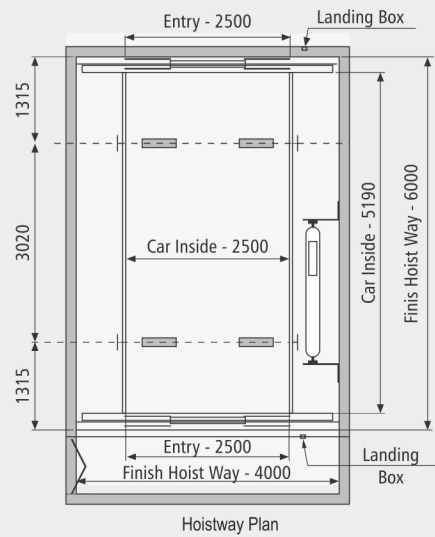

Rated Load

> 3t

Save Construction Area

80%

MRL Elevator

Machine Roomless Elevator

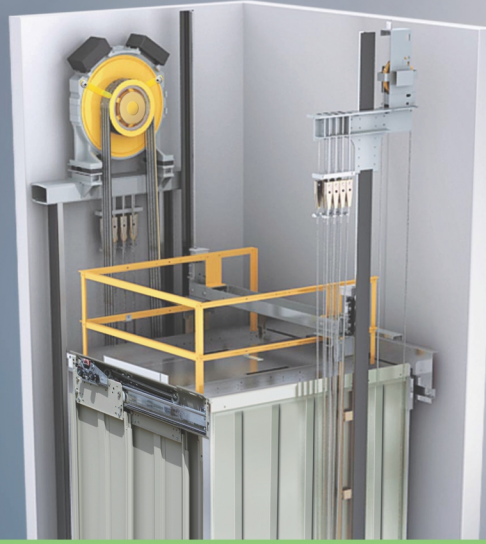

Available Rated Speed : 1.00 / 1.50 / 2 MPS
 Max Travel Height : 66 M
 Available Rated Capacity : 340 to 1768 Kgs
 Max Passengers : 05 to 26 Person

Minimal Space.
 Maximum Value !



In order to know the concept of environmental protection, energy saving, saving building area, improve the degree of freedom in design is the responsibility of the HOIST elevators without machine room, fully reflects the green spirit of humanity, the elevator needs only one independent well space, without room, with the same load weight level than conventional elevators, saving energy by 40%, save construction area of 10%.



Advantages

- Latest Technology in The World
- Smoothest Travel
- Absolute Freedom in Building Designs
- Substantial Saving On Electricity Cost
- Save The Construction Cost
- More Safe

Reduction in Elevator Equipment Area of 40%

- Significant Energy Saving
- Low Noise
- Compact Design

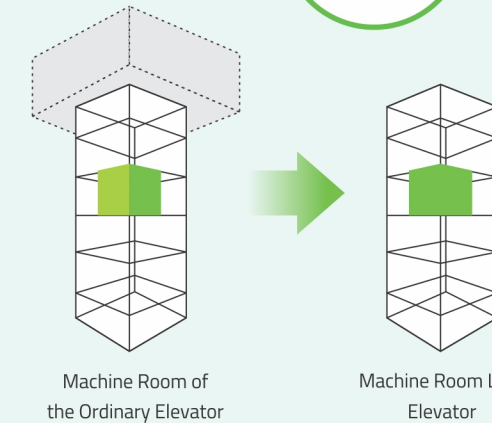

Simple Think's You Can Do To Save Time with MRL Elevator

Gear Less / Machine Room Less (MRL) Automatic Door - Passenger Lift
 Automatic Centre Opening / Telescopic Doors - MRL lifts

No. of Person	Rated Capacity KG	Speed M/S	Entrance Width (E) MM	Car Size (A X B) MM	Hoistway Dimensions (C x D) MM	Pit MM	Over Head MM
6	408	1.00	700	1100 X 1000	1600 X 1600	1500	4800
		>1.50<1.75			1850 X 1450	1800	5000
		2.5			1900 X 1450	2500	5500
8	544	1.00	800	1100 X 1300	1750 X 1750	1500	4800
		>1.50<1.75			1850 X 1750	1600	4800
		2.5			1900 X 1750	2500	5500
10	680	1.00	800	1300 X 1350	1950 X 1800	1600	5000
		>1.50<1.75			2050 X 1800	1800	5000
		2.5			2100 X 1800	2500	5500
13	884	1.00	900	1300 X 1700	1950 X 2150	1600	5000
		>1.50<1.75			2050 X 2150	1800	5500
		2.5			2100 X 2150	2500	5500
16	1088	1.00	1000	1500 X 1750	2150 X 2200	1600	5000
		>1.50<1.75			2250 X 2200	1800	5000
		2.5			2300 X 2200	2500	5500
20	1360	1.00	1000	1500 X 2000	2200 X 2450	1600	5000
		>1.50<1.75			2300 X 2450	1800	5500
		2.5			2350 X 2450	2500	6000

New generation permanent magnet synchronous gearless traction machine



Different Types of Car Parking Solution



Two Car Parking System



Electric Scissor Car Lift



Car Puzzle Parking

Home Elevator



Eco - friendly home elevators with precision engineering

Home elevators not only increase the value of your home, but can also provide you stunning showpiece. At the same time, home lifts can allow the disabled and elderly to easily move about a multi-level dwelling.

The term "home elevator" commonly refers to a lift enclosed in a shaft, and which can travel vertically as much as 15 m. (50 ft.). Home elevators make it easier to carry groceries, laundry or anything else from one floor to another. And today, they're fully customizable - choose from a wide range of materials, such as marble walls or stained glass, to turn your home elevator into an expression of your own unique style!



Innovative design and space-saving solution for your home

Available Rated Speed : 0.30 / 0.63 MPS
 Max Travel Height : 12 M
 Available Rated Capacity : 204 to 272 Kgs
 Max Passengers : 3 to 4 Passengers

Hydraulic Elevator



For Low Rise

Green Solution for Better Tomorrow



Looking for a low-maintenance elevator Hydraulic lifts provide the advantages of being relatively inexpensive, safe and easy to maintain. They're very convenient and cost-effective solution for low-rise buildings with low traffic.

Hydraulic elevators have been rated the safest option for home elevators. They boast superb user friendliness and easy access machine room located at the basement. Once they are put in place, hydraulic elevators provide the smoothest rides possible.



Available Rated Speed : 0.30 MPS
 Max Travel Height : 30 M
 Available Rated Capacity : 225 / 1800 Kgs
 Max Passengers : 03 / 24 Passengers



Hydraulic Goods Lift



High Car Ceiling Height : 2100mm

Electric Fan (Option)

LED Down Light Type (CE-EDB-C30)



LED Rectangle Cover Light type (CE-EDB-A30)

High Entrance Height 2000mm

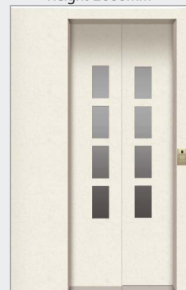

Entrance
 • Doors / Frame : Coated steel plate
 • Windows : Gray smoked plastics



The Long Car Cage will contribute to more comfortable access in your home, especially for wheelchair Users.

Single Phase Power



Mini Gearless Machine

- Safe and reliable for elders and children
- It does not require machine room
- Require minimum space
- Noiseless and easy in maintenance
- Wide range of design to suit style of bungalows

Persons	Load KG	Car Inside		Lift Well		Entrance
		A	B	C	D	
4	272	800	800	1400	1400	600
6	408	900	1100	1500	1800	700

• All dimensions are in mm.

Features

- ▶ Wide load carrying capacity
- ▶ Simple, robust design.
- ▶ Minimum overall height.
- ▶ Controlled peak deceleration.

Benefits

- ▶ Required low overhead & low pit.
- ▶ Simple structure requirement.
- ▶ Quick to install.

Power Pack Unit

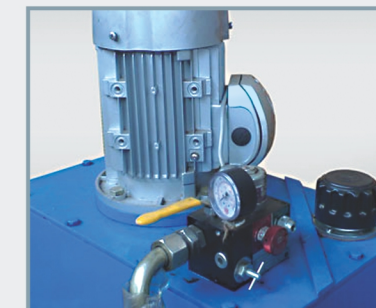

Hydraulic Goods Lift

HOLE TYPE ACTING

It is a directly acting suspension with a simple or split piston. It is the simplest solution of suspension for any load.

Persons	Capacity Kg	Car-W	Car-D	Shaft-W	Shaft-D
		(A)	(B)	(C)	(D)
3	225	800	1100	1500	1500
4	300	850	1050	1550	1550
5	375	1000	1200	1600	1600
6	450	1100	1250	1700	1700
8	600	1200	1500	1700	1800
10	750	1200	1700	1700	2000
12	900	1300	1800	1900	2100
15	1125	1300	2200	2000	2500
20	1500	1400	2500	2100	2800
24	1800	1500	2500	2200	2800

ROPE TYPE - Single Cylinder

It is a single side indirectly acting suspension with wire ropes having one piston for regular loads.

Persons	Capacity Kg	Car-W	Car-D	Shaft-W	Shaft-D
		(A)	(B)	(C)	(D)
3	225	800	900	1300	1300
4	300	850	1050	1350	1450
5	375	1000	1100	1500	1500
6	450	1100	1150	1600	1550
8	600	1100	1400	1600	1800
10	750	1200	1550	1700	1950
12	900	1300	1650	1800	2050
15	1125	1300	2000	1800	2400
20	1600	1400	2400	1900	2800

Variation Car Design



Stainless Steel Hairline Cabin



Gold Designer Cabin

Energy Efficient :
Perfection latest permanent magnet gear less machinery and eco drives utilizes 30% lesser energy.

Spacious :
Special arrangement of the components inside hoist way create more of the cabin space.

Speed :
Specially designed high speed elevator to minimize the queue waiting time.

Smart :
Latest smart features like auto parking, restricted entry make perfection elevator more smarter.

Customized Design :
We let our customers choose from options of cabin design, door type, ceiling, flooring and accessories.

Design lines, colors and materials.
Design that speaks to your senses.



CAR CEILING



Stainless Steel with Glass Cabin



Golden Designer With Glass Cabin



Stainless Steel Hairline Cabin



Stainless Steel With Glass Cabin



Stainless Steel Strip Cabin



Stainless Steel with Glass Cabin



Stainless Steel Mirror Finish Cabin

HANDRAIL



Stainless Steel Hairline with Glass Cabin



Stainless Steel Hairline with Glass Cabin



Stainless Steel Designer Cabin



Golden Designer Cabin



Golden Designer Cabin

ETCHING DESIGNS

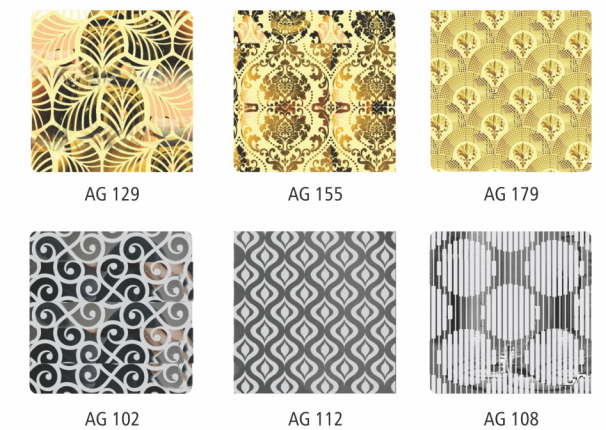

COP & LOP

Car Operating Panel & Landing Operation Panel

HOIST ELEVATORS features a wide variety of operating panels for lifts with great flexibility in special construction.



Display

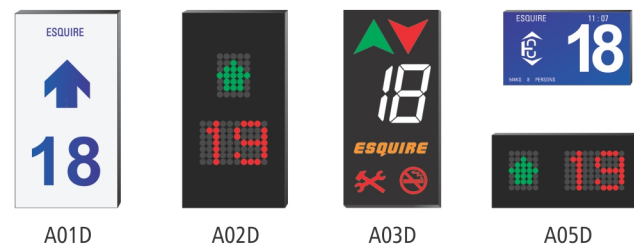

Gearless Machine Unit



Green Installment Saving
Environment Friendly

40%
Power Saving



Geared Machine Unit

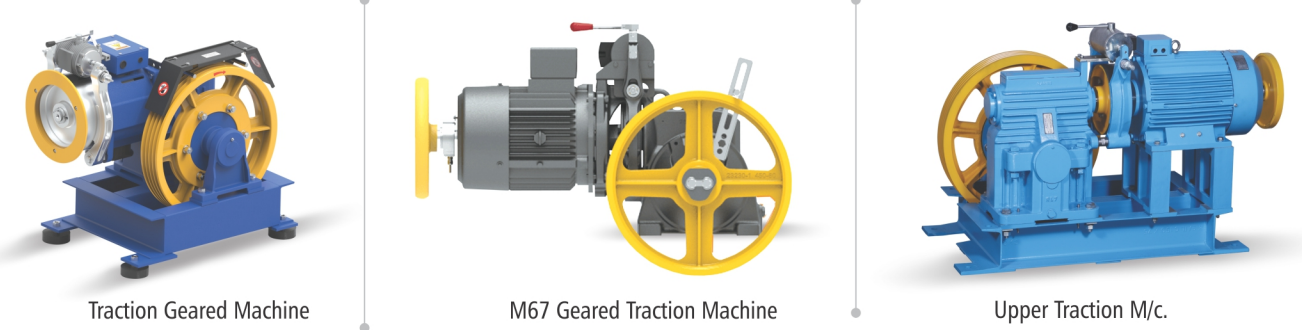

Control Panel

The safe and More
Energy-Saving
Integrated control

VVVF Drive

